



System flowchart
Cardiohelp System
Heart-Lung Support System

Contents

Cardiohelp-i System.....	3
Country kit.....	3
Temperature monitoring	3
Venous bubble sensor	4
Venous probe.....	4
Pressure transducer	4
Air emboli protection.....	4
Emergency Drive holder	4
Sprinter Cart / Sprinter Cart XL	4
Heater Unit HU 35	4
Fixation	5
Transport.....	5
Battery calibration unit	6
Equipotential bonding cable	6
Disposables.....	6
Extra USB memory stick.....	6
Connectivity to MSync	6
Service	6
Training	6

Heart-Lung Support System / Cardiohelp System, system flowchart

Cardiohelp-i System

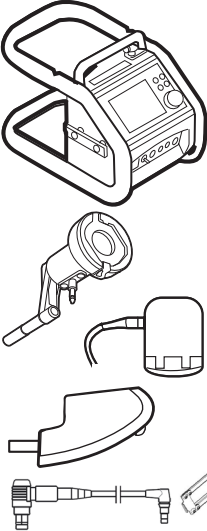

Cardiohelp-i
(with software version "step 2") *
70108.1812

- Includes:
 - Cardiohelp Emergency Drive (without holder).
 - Flow/bubble sensor for 3/8" x 3/32" tubing, length 0.9 m.
 - Venous Probe with connection cable for HLS Set Advanced and Sets with Quadrox-iR, length 0.32 m (S_vO₂, Hb, Hct, T_{ven}).
 - Connection cable disposable, 16 pins, length 0.21 m.
 - Transport Guard for Cardiohelp disposables.
 - USB memory stick 4 GB.
- Country kit must be ordered separately (see below).**

* Information of the software version will be identified via the corresponding country kit.

Note! Not all products listed here are available in all countries. For details contact your sales representative.

Note! Please ensure that you select a suitable country kit according to the provided voltage in your country. In case of doubt have an authorized service technician measure the actual supply voltage at the particular power outlet.

 = and/or

 = box for ordered quantity

Dark grey line = standard system configuration

Country kit

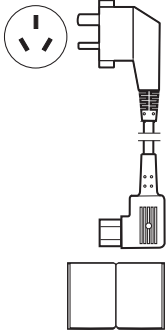

Country kit, Cardiohelp 100-240 V 50/60 Hz
(for Cardiohelp-i with software version "step 2")
Chinese (ZH), Power cable with plug type I
70106.4797

- Includes:
 - Mains power cable, 2.50 m.
 - Instructions for use.

Note:
The machine itself is able to handle the whole frequency bandwidth of 50–60Hz within each power supply.

Temperature monitoring

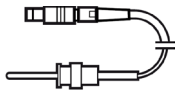

TPO-D L1.8
Temperature probe
70105.4562

- Defibrillation protected.
- Shielded cable.
- Length 1.8 m.
- Sensor shaft size (Ø x length): 3.175 x 44.958 mm (0.125" x 1.77").
- Compatible with:
 - Quadrox-iR.

Venous bubble sensor



**BS 3/8x3/32 L1.7
Bubble Sensor for 3/8" x 3/32" tubing**
70105.5720

- Length: 1.7 m.
- For use with HLS Set Advanced and sets with Quadrox-iR.
- Coded with blue spout.

Venous probe

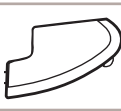

Venous probe
70104.8803

- Measurement head

Pressure transducer

Four pressures

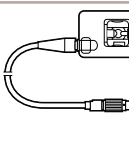

Medex Transducer Kit 960 LogiCal
70104.9184

- Includes:
 - Transducer cable 1.8 m, for pressure module connection.
 - Pressure transducer with transducer plate.
 - Marker kit 4 colours.



**Medex MX 960 LogiCal
pressure dome**
70102.2744

- Disposable.

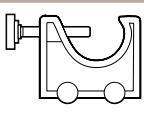

**Medex MX 960 LogiCal
transducer holder**
70102.0721

- Pole mount.
- Holds 4 Medex LogiCal transducers.

Air emboli protection

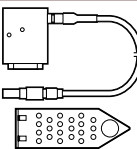

**CLS
Capacitive level sensor kit**
70104.9490

- Includes:
 - Capacitive level sensor with cable 2 m.
 - Level sensor pad, 100 pcs.

Extra sensor pads

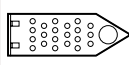

Level sensor pad, 100 pcs
70102.2208

- Disposable.
- To be attached to the venous bubble trap / reservoir at the chosen level.

Emergency Drive holder

Rail holder

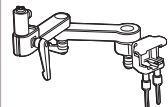

**HKH 9101-R
Cardiohelp Emergency
Drive holder for standard
rail 10 x 25 mm**
70104.9304

a/o

Mast holder

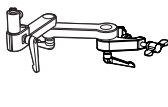

**HKH 9101-M
Cardiohelp Emergency
Drive holder for mast**
70104.8006

Sprinter Cart / Sprinter Cart XL

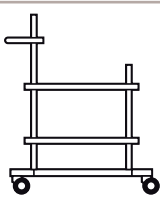

Sprinter Cart / Sprinter Cart XL

- Note: If you use Cardiohelp-i on the Sprinter Cart / Sprinter Cart XL, the Cardiohelp Emergency Drive has to be mounted on a Cardiohelp Emergency Drive holder.

See separate system flowchart, which also includes Gas Control Equipment.

Heater Unit HU 35

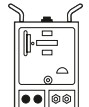

Heater Unit HU 35
See separate system flowchart.

Fixation



**HKH 9102-M
Cardiohelp holder for mast**
70104.9584

- To attach a Cardiohelp Device on a mast (diameter 38 mm).

Extra adapter for mast Ø 33 mm



Mast adapter D33 H45
70103.3314

- For mast mounting, diameter 33 mm, height 45 mm.

Extra adapter for mast Ø 30 mm



Mast adapter D30 H45
70105.1531

- For mast mounting, diameter 30 mm, height 45 mm.

Transport

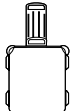

Transport case for Cardiohelp-i
70105.1373

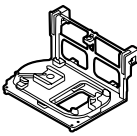

**HKH 8860
Cardiohelp mobile holder**
70105.0897

- Transport holder for air transport and ambulance.
- Mandatory for inter-hospital transport.
- Rail spacing: 382.5 mm.
- Includes:
 - Infusion pole.
 - Cardiohelp Protection Cover.



Transport case for Emergency Drive
70107.2672

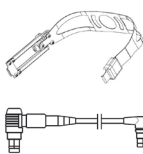

Transport Guard for Cardiohelp disposables – Kit
70107.2671

- Includes:
 - Transport Guard for Cardiohelp Disposables.
 - Fixture for Cardiohelp.
 - Connection cable for venous probe, length 0.32 m.

Note:

- This kit must be installed by a service technician.

Ground transport

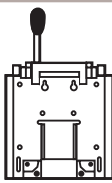

**HKH 8820
Wall holder for ambulance**
70104.5366

- Mandatory for ambulance transport.

Note:

- Individual transport approval is mandatory!
For transport approval issues, please contact Getinge.

Air transport



**HKH 8850
Base plate for helicopter**
70104.5411

- Mandatory for the following rail spacings: 279.0 mm; 304.8 mm; 440.0 mm.
- Optional for the rail spacing: 382.5 mm.

Note:

- Individual transport approval is mandatory!
For transport approval issues, please contact Getinge.

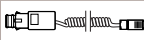

**Power supply cord
DC-carsocket**
70104.8805



Backpack for gas bottle
70105.1507

Battery calibration unit

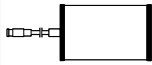

Battery Calibration Unit
70105.4127

Equipotential bonding cable

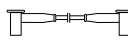

Equipotential bonding cable

1.0 m	70105.5328
2.0 m	70105.5348
3.0 m	70105.5349
6.0 m	70105.5350

- Connecting leads for potential equalization.
- On both ends with assembled right-angled, spring-loaded socket.

Disposables

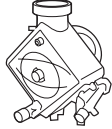

Disposables

- To be ordered separately from Getinge.

Extra USB memory stick



USB memory stick
14 GB for data storage
70104.9707

Connectivity to MSync

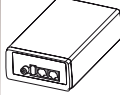

MSync with holder for rail

- Including:
 - PSU (power supply unit).
 - RS232 cable (shielded), length 0.7 m.
 - USB cable, length 1.8 m.

To be ordered separately from Getinge Critical Care.
Order number 68 81 603.

Service



Service contract

- To be specified by technical dept.

Training



Application training

- For details contact your local representative.



Technical training

- For details contact your local representative.



With a firm belief that every person and community should have access to the best possible care, Getinge provides hospitals and life science institutions with products and solutions aiming to improve clinical results and optimize workflows. The offering includes products and solutions for intensive care, cardiovascular procedures, operating rooms, sterile reprocessing and life science. Getinge employs over 10,000 people worldwide and the products are sold in more than 135 countries.

This document is intended to provide information to a Chinese audience.

Cardiohelp may be pending regulatory approvals to be marketed in your country. Contact your Getinge representative for more information.

© Copyright 2025 by Getinge · All rights reserved.

Manufacturer · Maquet Cardiopulmonary GmbH · Kehler Str. 31 · 76437 Rastatt · Germany · +49 7222 932-0

www.getinge.com